



70m Cat.6 4x4 HDMI 4K60 Matrix Extender

Full User Manual

English

No. 38328 V2

[lindy.com](https://www.lindy.com)

Safety Instructions**! WARNING !**

Please read the following safety information carefully and always keep this document with the product.

Failure to follow these precautions can result in serious injuries or death from electric shock, fire or damage to the product.

Touching the internal components or a damaged cable may cause electric shock, which may result in death.

This device is a switching type power supply and can work with supply voltages in the range 100 - 240 VAC For worldwide usability four different AC adapters are enclosed: Euro type, UK type, US/Japan type and Australia/New Zealand type. Use the appropriate AC adapter as shown in the picture and ensure it is firmly secured in place and does not detach by pulling before installing into a power socket.

To reduce risk of fire, electric shocks or damage:

- Do not open the product nor its power supply. There are no user serviceable parts inside.
- Only qualified servicing personnel may carry out any repairs or maintenance.
- Never use damaged cables.
- Do not expose the product to water or places of moisture.
- Do not use this product outdoors it is intended for indoor use only.
- Do not place the product near direct heat sources. Always place it in a well-ventilated place.
- Do not place heavy items on the product or the cables.
- Please ensure any adapters are firmly secured and locked in place before inserting into a wall socket

**Instructions for Use of Power Supply**

To connect the adapter

Slide the desired plug adapter into the power supply and rotate clockwise until it locks into place.

To remove the adapter

Press the push button latch.

While pressed, rotate the adapter anticlockwise.



Introduction

Thank you for purchasing the 70m Cat.6 4x4 HDMI 4K60 Matrix Extender. This product has been designed to provide trouble free, reliable operation. It benefits from both a LINDY 2-year warranty and free lifetime technical support. To ensure correct use, please read this manual carefully and retain it for future reference. The Lindy 70m Cat.6 4x4 HDMI 4K60 Matrix Extender is a high-performance, professional solution for distribution of 4K HDMI signals to multiple displays using standard Cat.6 network cables from 4 separate HDMI sources.

Package Contents

- 70m Cat.6 4x4 HDMI 4K60 Matrix Extender
- 4 x Cat.6 HDMI Receiver
- 12VDC 2.5A Multi-country Power Supply (UK, EU, US & AUS), Barrel Size: 5.5/2.1mm
- IR Remote with CR2025 Battery
- 4 x IR Emitter Cable, 1.5m
- 4 x Receiver Cable, 1.5m
- RS-232 Male to Female Cable, 1.5m
- 3-Pin Phoenix Connector
- 10 x Mounting Ears with screws
- Lindy Manual

Features

- Distribute 4K HDMI signals to up to 4 displays in multiple locations from 4 different sources
- Supports resolutions up to 4K@60Hz, with additional support for HDR
- Features 4 HDMI outputs on the transmitter for local monitoring, which run simultaneously with the extension output
- Supports Power over Cable (PoC) to the receivers, only a single power supply is required for operation
- 4K to 1080p Downscaling on each output
- Advanced EDID Management
- Push Button, IR, RS-232, LAN & Web-Gui Control

Specification

- Supported Bandwidth: 18Gbps
 - Maximum Distance: 70m (229.66ft)
 - Maximum Resolution: 3840x2160@60Hz 4:4:4 8bit with HDR support
 - The following distance and resolution combinations are supported:
 - 70m with Cat.6 cable: 1920x1080@60Hz 4:4:4 8bit, 3D@1920x1080
 - 40m with Cat.6A cable: 3840x2160@60Hz 4:4:4 8bit / 4:2:2 12bit
 - HDCP Support: 2.2
 - Supported Audio Formats: LPCM 2.0/2.1/5.1/6.1/7.1, Dolby Digital, Dolby TrueHD, Dolby Digital Plus (DD+), DTS-ES, DTS HD Master, DTS HD-HRA, DTS-X
 - IR Support: 20~60KHz
 - CEC Support: Pass-through
 - Housing Material: Metal
 - Colour: Black
 - Operating Temperature: 0°C - 40°C (32°F - 104°F)
 - Storage Temperature: -20°C - 60°C (-4°F - 140°F)
 - Humidity: 20-90% RH (non-condensing)
 - ESD Protection: Human-body Model: ±8kV (Air-gap discharge), ±4kV (Contact discharge)
 - Power Consumption: 19.68W (Maximum)
-

Connectors

- Transmitter Input: 4 x HDMI Type A (Female)
- Transmitter Output: 4 x HDMI Type A (Female), 4 x RJ-45 (Female), 4 x 3.5mm IR (Female), RJ-45 LAN Control (Female), 3-Pin Phoenix Connector (Female)
- Receiver Input: RJ-45 (Female), 3.5mm IR (Female)
- Receiver Output: HDMI Type A (Female)

Product Overview

Matrix Unit

Front Panel



- Power Switch: Push the switch to power the matrix on or off.
- Power LED: The LED will illuminate green once powered on.
- IR: IR receiver eye for control from the IR remote.
- Output 1 – 4 Push Buttons & HDMI Source LED: Push the Output 1 – 4 button to select the HDMI Input connection for the corresponding output port. The corresponding input LED will illuminate.

Rear Panel

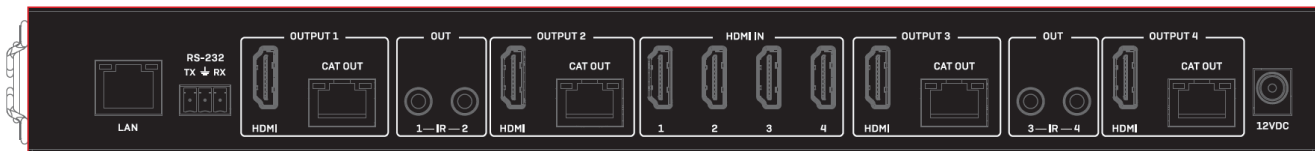

- LAN: Connect to an active Ethernet connection with a Cat.6 cable for IP control.
- RS-232: Connect to a PC or control system with the 9-pin RS-232 cable for RS-232 command control.
- HDMI Output 1 – 4: Connect to a HDMI display using HDMI cable.
- Cat Output 1 – 4: Connect to the Cat In Port of the receiver using Cat.6 or above cable.
- IR Out 1 – 4: Connect the IR emitter cable for control from the receiver side of the installation using the IR receiver cables.
- HDMI In 1 – 4: Connect to an HDMI source device with an HDMI cable.
- 12VDC: Connect the 12V 1.25A Power Supply.

Receiver

- HDMI Out: Connect to an HDMI display using HDMI cable.
- Cat In: Connect to the Cat Out port of the matrix using Cat/6 or above cable.
- Service: Reserved for Firmware Updates.
- IR In: Connect the IR Receiver cable to control the source side of the installation.
- 12VDC: Connect a 12V 1.25A Power Supply. Please note the receiver can also be powered by the matrix using PoC (Power over Cable).

Installation

Please follow the below instructions for installation.

Lindy advises using high-quality HDMI cables up to 3m in length on the input, and 3m in length on the output. Cat.5e cabling can also be used however this will impact the maximum distance possible, therefore Cat.6 cable or above is recommended for use. Please ensure all devices are switched off prior to installation.

1. Connect an HDMI display to the required receiver unit using HDMI cable.
2. Connect a Cat.6 or above network cable to the Cat In port of the receiver unit.
3. Connect the opposing end of the Cat.6 cable to one of the 4 Cat Out ports of the matrix.
4. For local HDMI distribution, connect up to 4 HDMI displays to the local HDMI Out ports of the matrix unit.
5. Connect up to 4 HDMI source devices to the HDMI In of the matrix unit.
6. Connect the multi-country power supply to the DC jack of the matrix unit and plug into a mains socket.
7. Switch on all devices. The Power LED of the matrix and receiver units will illuminate once power has been supplied. Power is provided to the receivers over the network cable using PoC.
8. For additional infrared remote signal functionality, connect the included IR Extension Cables to the matrix and receiver units, using the IR emitter cable with the IR Out port on the matrix and the IR receiver with the IR in port of the receivers. Please ensure the emitter cable is in front of the IR port that will be controlled, while the IR receivers are in line of sight of the IR remote.

Control

The matrix includes various methods of control above the push buttons on the main unit for simple content distribution, or for integrating into control systems.

IR Control

The unit supports one-way IR matrix function. When the matrix is connected to a receiver via a Cat.6 cable, you can control the input source device (local end) by the IR control signal from the receiver (remote end). IR signal follows video switch to change. For example, the HDMI output signal on the receiver 1 comes from the HDMI IN 1 port, so IR input signal of the receiver 1 will emit to IR OUT 1 port of the Matrix. The HDMI output signal on the receiver 3 comes from the HDMI IN 2 port. Then, IR input signal of the receiver 3 will emit to IR OUT 2 port of the Matrix and so on. The IR OUT signal of the Matrix depends on the IR remote of source device.

It's also possible to assign ports following the steps below:

1. Power on the matrix or put the matrix into standby mode.
 2. Output 1: Press 1, 2, 3 or 4 to assign the HDMI Input to HDMI Output 1.
 3. Output 2: Press 1, 2, 3 or 4 to assign the HDMI Input to HDMI Output 2.
 4. Output 3: Press 1, 2, 3 or 4 to assign the HDMI Input to HDMI Output 3.
 5. Output 4: Press 1, 2, 3 or 4 to assign the HDMI Input to HDMI Output 4.
 6. < >: Select the previous or next HDMI Input.
-

IR Cable Pin Out

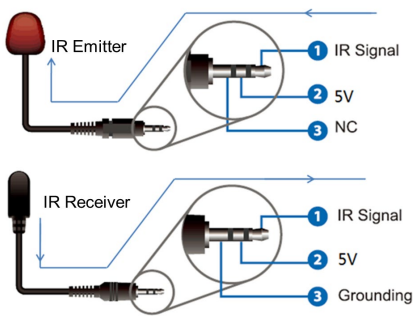

Web-Gui Control

Please follow the steps below to control the matrix via Web-Gui.

The default IP address is 192.168.1.100. The matrix’s IP address can also be found using RS-232 control. Send the ASCII command “r ipconfig!” using a serial command tool. The following feedback will then be shown. The IP address will vary, the below is an example only.

```
IP Mode: DHCP
IP: 192.168.2.209
Subnet Mask: 255.255.255.0
Gateway: 192.168.2.1
TCP/IP port=8000
Telnet port=23
Mac address: 6C:DF:FB:07:1C:E2
```

Connect a PC to the LAN port of the matrix using a UTP Cat.6 or above cable. Set the IP address to be in the same network segment as the matrix.

Input the current IP address of the matrix in the browser of the PC. This will open the Web-Gui page. Once into the Web-Gui, a login page will be shown.



Select the username from the list and enter the password. The default username and passwords are as follows:

Username: User, Password: user

Username: Admin, Password: admin

Once entered, please select Login and the Status page will open.

Status Page

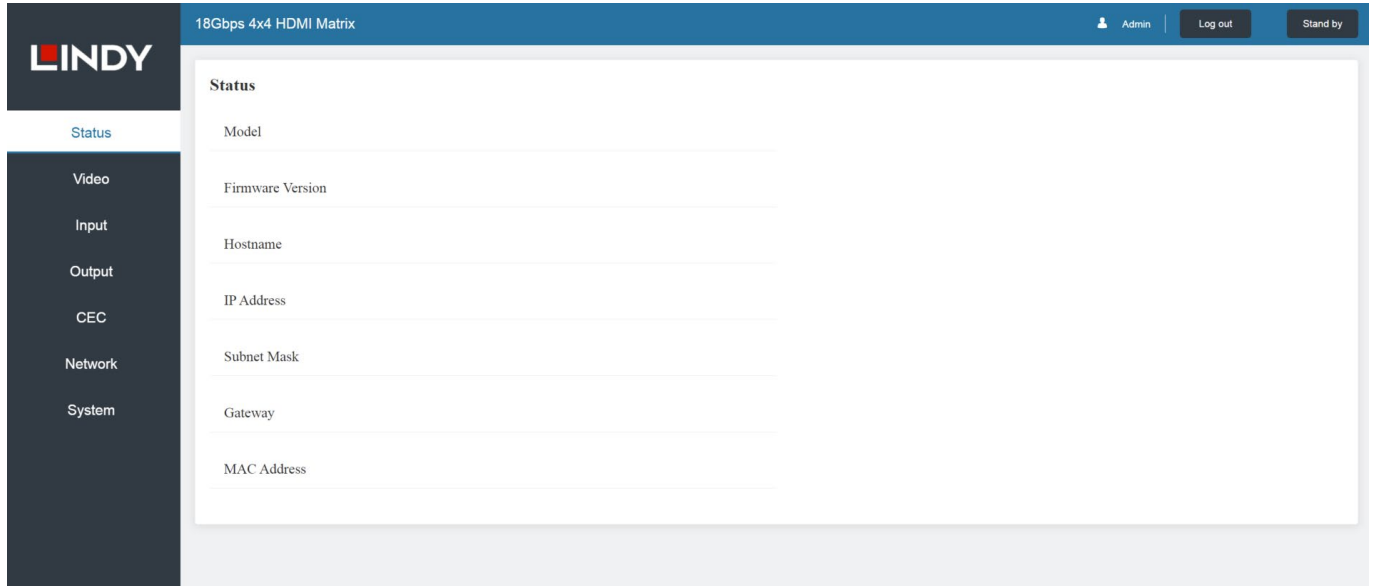

This page provides basic information about the extender, the current firmware version, and the network settings of the device.

Video Page

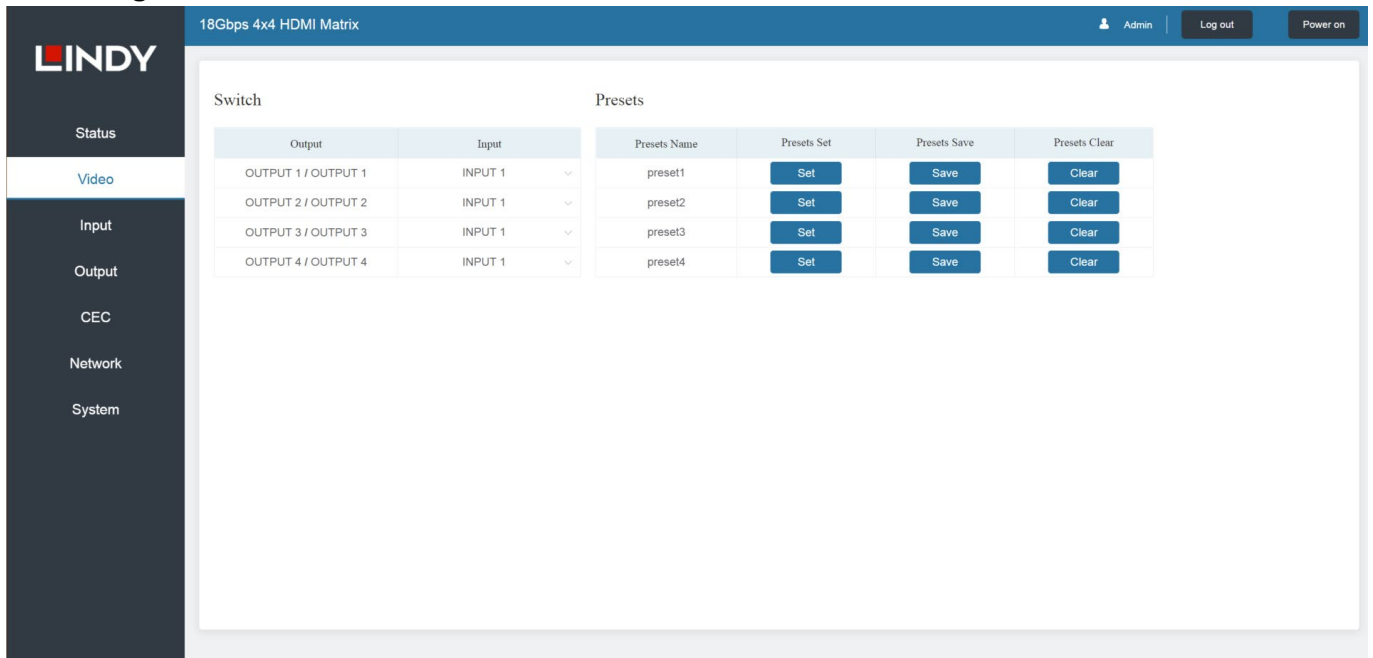

The video page allows for simple switching functionality as well as creating, naming, and assigning certain pre-set layouts.

Output: The matrixes output port. Select the source signal required from the Input drop down.

Input: Select the input source from the drop down for the corresponding output port.

Pre-sets Name: Rename the current layout. Please note the max character length is 12.

Pre-sets Set: Restore the settings of the last previously saved layout.

Pre-sets Save: Save the current layout.

Pre-sets Clear: Clear the currently saved layout.

Input Page

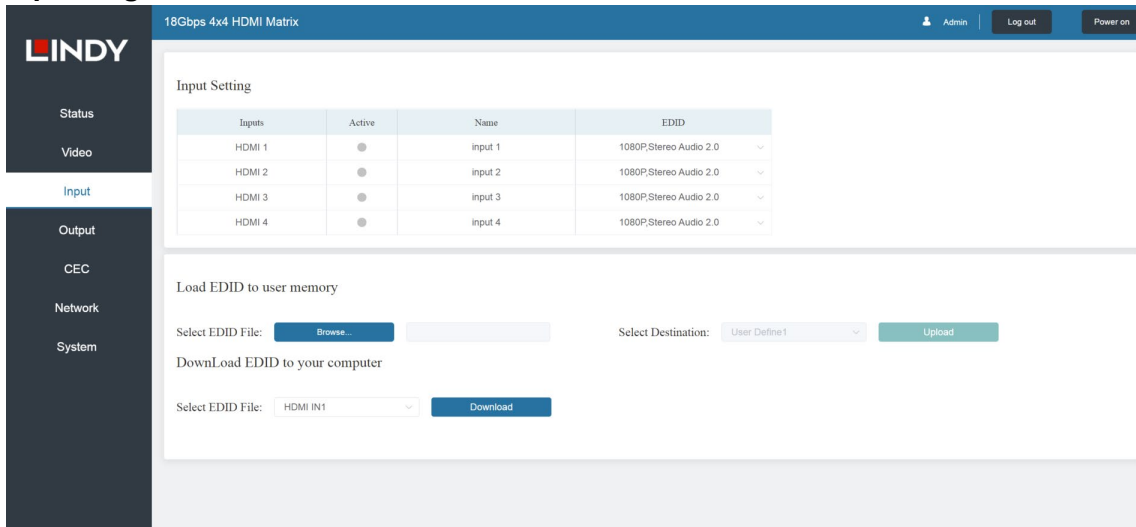

The input page allows for management of the input connections and the EDID settings.

Inputs: Input connection of the matrix.

Active: Indicates if the channel is connected to a source signal.

Name: The input channels name. This can be edited. Please note the max character length is 12.

EDID: Set current input channels EDID:

Set User EDID – Select the Browse button and select the bin file. If the wrong file is selected there will be a prompt.

Please ensure the correct file is selected, then ensure the name of the file is correct. Select User 1 or User 2 and select Upload. Once successful a prompt will show.

To download the EDID file for the corresponding input channel, select from the Select EDID file drop down list. Select Download to download the corresponding EDID file.

Output Page

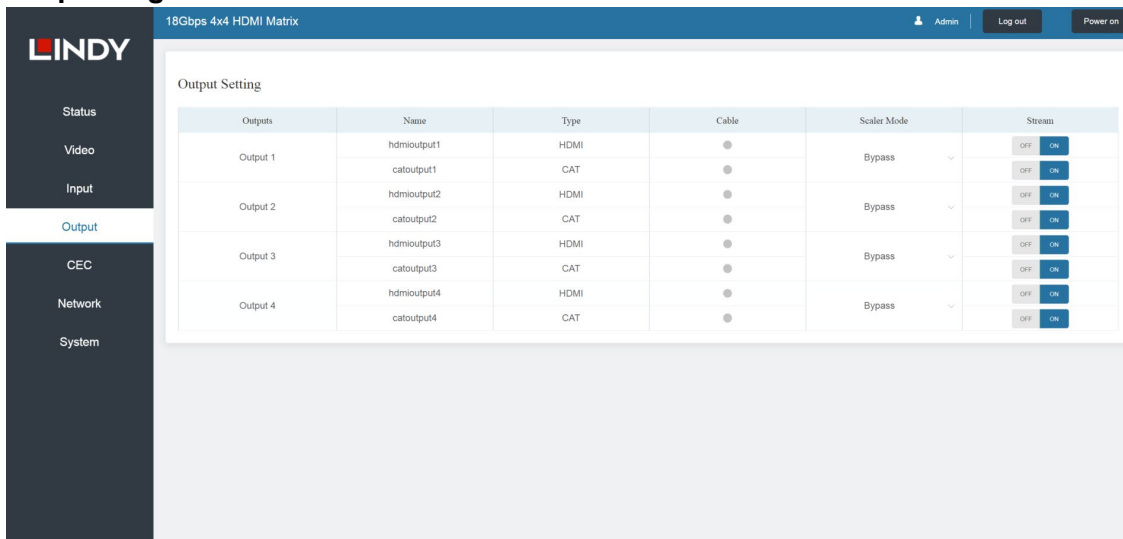

The Output Page allows for management of both the HDM and Cat outputs including setting output resolutions.

Outputs: Output channel of the matrix.

Name: The output channel's name. This can be edited. Please note the max character length is 12.

Type: The output channel connection type.

Cable: This indicates the current connection status of the output port. When a connection is made between the output port and a display, the indicator will be green. If not, this will remain grey.

Scaler Mode: Set the output resolution.

Stream: Turn the video output on or off.

CEC Page

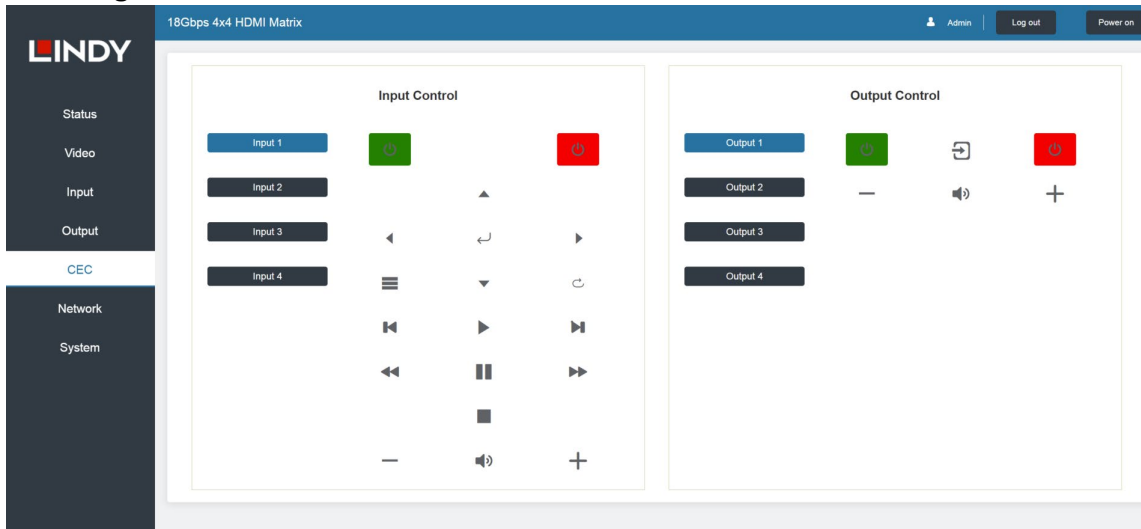

This page allows for management of the CEC function.

Input Control: This allows for CEC functions that can be sent to the corresponding input device. Please note the connected device must support CEC functionality.

Output Control: This allows for CEC functions that can be sent to the corresponding HDMI output device.

Please note: the connected device must support CEC functionality, anyway some devices could have some incompatibility issues.

Network Page

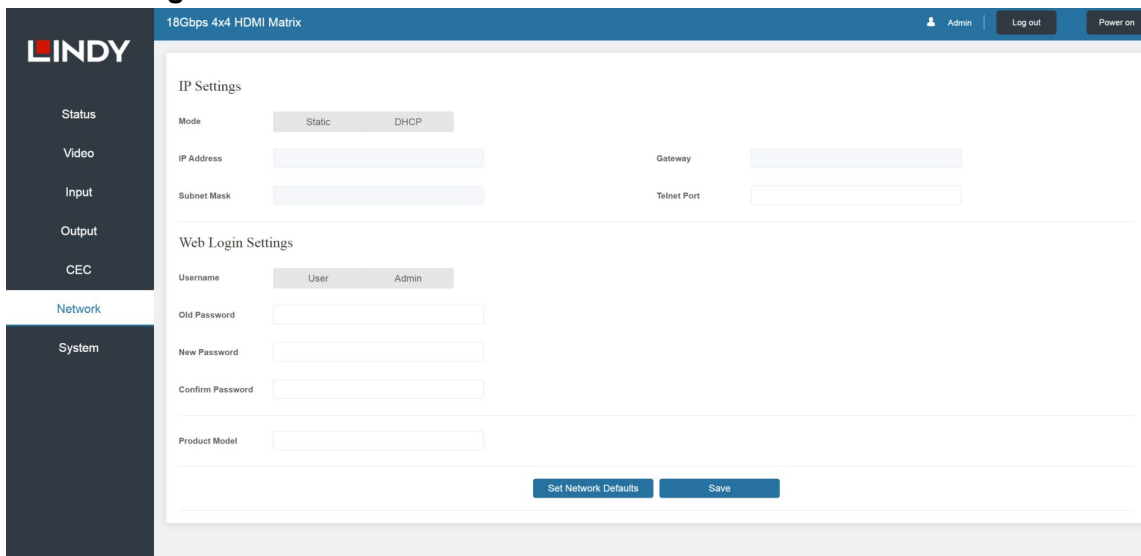

This page provides an overview and allows for management of the network settings.

Select Set Network Defaults. This will open a prompt.

Select OK to search for the IP address again.

Once the search has finished, the Login page will open again, and the default network setting is finalised.

Modify User Password:

Select User and enter the old password, new password, confirm password and then select Save. Once the change has been confirmed a prompt will show.

Please note the password field cannot remain empty, remain the same as the old password and the new password and confirm password must be identical.

Modify Network Setting:

Modify the Mode, IP Address, Gateway, Subnet Mask and Telnet Port and select Save to save the settings which take effect immediately. After any change are made, if the Mode is “Static”, it will switch to the corresponding IP address. If the Mode is set to DHCP, it will automatically search and switch to the IP address assigned by the connected router.

System Page

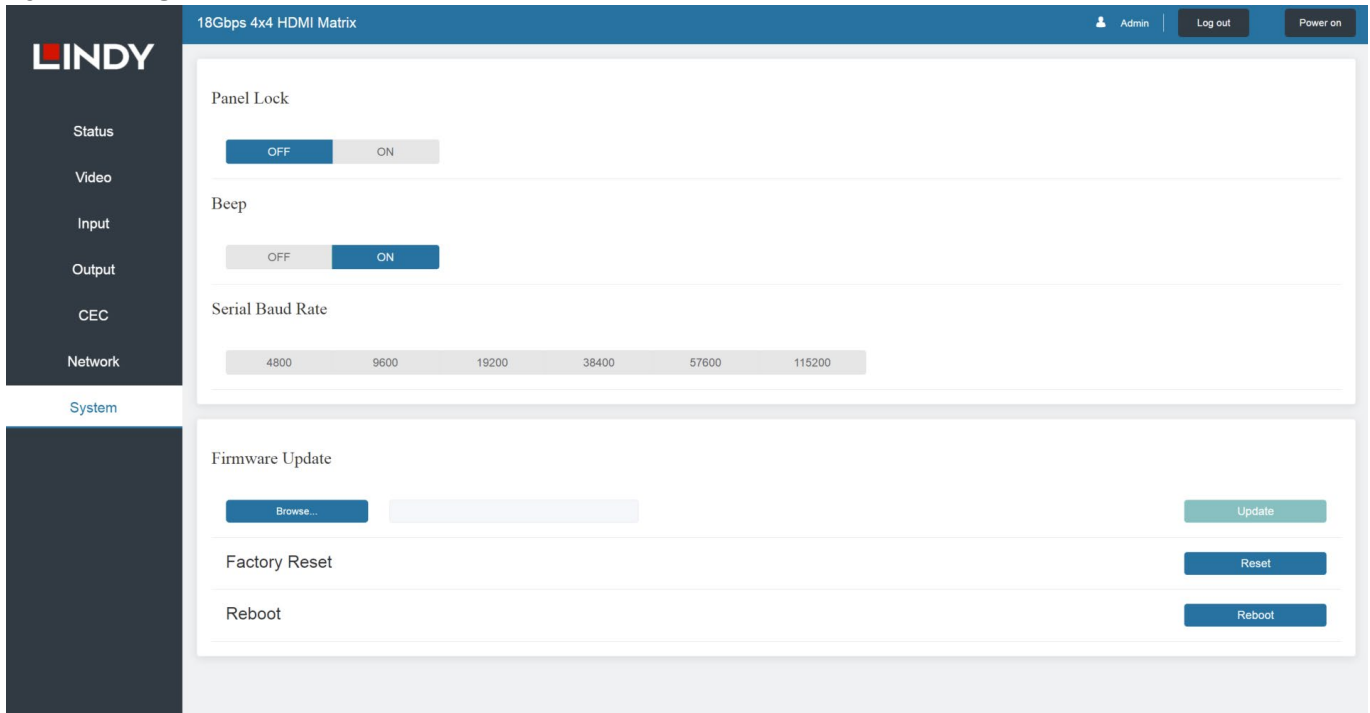

Panel Lock: Select On to lock the push buttons on the main unit. Select Off to unlock.

Beep: Select to turn the main units beep notification sound.

Serial Baud Rate: Select the appropriate value to set the serial baud rate.

Firmware Update: Click Browse and then select the firmware update file and click Update to complete the firmware update.

Factory Reset: Select Reset to reset the matrix to its factory default settings.

Reboot: Select Reboot to reboot the matrix.

Please note: After a factory reset or reboot it will automatically switch to the login page.

RS-232 Control

Using a RS-232 phoenix connector to RS-232 Male cable, the matrix can also be controlled using RS-232 commands. Connect the phoenix connector to the matrix and connect the RS-232 male connection to a RS-232 Female to USB cable. The USB connector can then be connected to a PC or laptop.

Open the serial command tool which can be found at your local Lindy website under Downloads.

The ASCII command list can be found below.

Serial Port Protocol.

Baud Rate: 115200

Data Bits: 8bit

Stop Bits: 1

Check Bit: 0

X – Parameter 1

Y – Parameter 2

! – Delimiter

Command Code	Function	Description	Feedback	Default Setting
Power				
s power z!	Power on/off the device, z=0~1 (z=0 power off, z=1 power on)	s power 1!	Power On System Initializing... Initialization Finished FW Version x.xx.xx	Power on
r power!	Get current power state	r power!	power on/power off	
s reboot!	Reboot the device	s reboot!	Reboot... Initialisation Finished FW Version x.xx.xx	

System Setup				
help!	List all commands	help!		
r type!	Get device model	r type!	Lindy 38328	
r status!	Get device current status	r status!	Get the unit all status: power, beep, lock, in/out connection, video/audio crosspoint, edid, scaler,hdcp, network status	
r fw version!	Get Firmware version	r fw version!	MCU BOOT: Vx.xx.xx MCU APP : Vx.xx.xx WEB GUI : Vx.xx	
r link in x!	Get device model	r type!	hdmi input 1: connect	
r link out y!	Get device current status	r status!	hdmi output 1: connect	
s reset!	Get Firmware version	r fw version!	Reset to factory defaults System Initializing... Initialization Finished! FW version x.xx.xx	
s beep z!	Get the connection status of the x input port , x=0~4(0=all)	r link in 1!	beep on beep off	
r beep!	Get the connection status of the y output port, y=0~4(0=all)	r link out 1!	beep on / beep off	
s lock z!	Reset to factory defaults	s reset!	panel button lock on panel button lock off	
r lock!	Enable/Disable buzzer function, z=0~1(z=0 beep off, z=1 beep on)	s beep 1!	panel button lock on/off	beep on
s save preset z!	Get buzzer state	r beep!	save to preset 1	
s recall preset z!	Lock/Unlock front panel button,z=0~1(z=0 lock off,z=1 lock on)	s lock 1!	recall from preset 1	panel button lock off
s clear preset z!	Get panel button lock state	r lock!	clear preset 1	
r preset z!	Save switch state between all output port and the input port to preset z, z=1~4	s save preset 1!	video/audio crosspoint	
s baud rate xxx!	Call saved preset z scenarios, z=1~4	s recall preset 1!	Baudrate:115200	
r baud rate!	Clear stored preset z scenarios,z=1~4	s clear preset 1!	Baudrate:115200	
s id z!	Get preset z infomation, z=1~4	r preset 1!	id 888	

Output Setting				
s in x av out y!	Set input x to output y, x=1~4, y=0~4(0=all)	s in 1 av out 2!	input 1 -> output 2	ptp
r av out y!	Get output y signal status y=0~4(0=all)	r av out 0!	input 1 -> output 1 input 2 -> output 2 input 4 -> output 4	
s hdmi y stream z!	Set output y stream on/off, y=0~4(0=all) z=0~1(0:disable,1:enable)	s hdmi 1 stream 1! s hdmi 0 stream 1!	Enable hdmi output 1 stream Disable hdmi output 1 stream Enable hdmi all outputs stream Disable hdmi all outputs stream	enable
s cat y stream z!	Set output y stream on/off, y=0~4(0=all) z=0~1(0:disable,1:enable)	s cat 1 stream 1! s cat 0 stream 1!	Enable cat output 1 stream Disable cat output 1 stream Enable cat all outputs stream Disable cat all outputs stream	enable
r hdmi y stream!	Get output y stream status, y=0~4(0=all)	r hdmi 1 stream!	Enable hdmi 1 stream	
r cat y stream!	Get output y stream status, y=0~4(0=all)	r cat 1 stream!	Enable cat 1 stream	
s hdmi y scaler z!	Set hdmi output y port output scaler mode, y=0~4(0=all), z=1~3(1=bypass,2=4k->1080p,3=Auto)	s hdmi 1 scaler 1! s hdmi 0 scaler 1!	hdmi output 1 set to bypass mode hdmi all outputs set to bypass mode	hdmi all outputs set to bypass mode
r hdmi y scaler!	Get hdmi output y port output mode y=0~4(0=all)	r hdmi 1 scaler !	hdmi output 1 set to bypass mode	
s cat y dsc mode z!	set cat output y port dsc mode status y=0~4(0=all) z=1~3(1=Cat cable distance normal Mode,2=Cat cable distance 35M Mode,3= Cat cable distance 70M Mode)	s cat 1 dsc mode 2!	cat out 1 dsc mode 2	Cat cable distance 35M Mode(35M)
r cat y dsc mode!	Get dsc mode of cat out y, y=0~4(0=all)	r cat 1 dsc mode!	cat out 1 dsc mode 2	

CEC Setting				
s cec in x on!	set input x power on by CEC, x=0~4(0=all input)	s cec in 1 on!	input 1 power on	
s cec in x off!	set input x power off by CEC, x=0~4(0=all input)	s cec in 1 off!	input 1 power off	
s cec in x menu!	set input x open menu by CEC, x=0~4(0=all input)	s cec in 1 menu!	input 1 open menu	
s cec in x back!	set input x back operation by CEC, x=0~4(0=all input)	s cec in 1 back!	input 1 back operation	
s cec in x up!	set input x menu up operation by CEC, x=0~4(0=all input)	s cec in 1 up!	input 1 menu up operation	
s cec in x down!	set input x menu down operation by CEC, x=0~4(0=all input)	s cec in 1 down!	input 1 menu down operation	
s cec in x left!	set input x menu left operation by CEC, x=0~4(0=all input)	s cec in 1 left!	input 1 menu left operation	
s cec in x right!	set input x menu right operation by CEC, x=0~4(0=all input)	s cec in 1 right!	input 1 menu right operation	
s cec in x enter!	set input x menu enter by CEC, x=0~4(0=all input)	s cec in 1 enter!	input 1 menu enter operation	
s cec in x play!	set input x play by CEC, x=0~4(0=all input)	s cec in 1 play!	input 1 play operation	
s cec in x pause!	set input x pause by CEC, x=0~4(0=all input)	s cec in 1 pause!	input 1 pause operation	
s cec in x stop!	set input x stop by CEC, x=0~4(0=all input)	s cec in 1 stop!	input 1 stop operation	
s cec in x rew!	set input x rewind by CEC, x=0~4(0=all input)	s cec in 1 rew!	input 1 rewind operation	
s cec in x mute!	set input x volume mute by CEC, x=0~4(0=all input)	s cec in 1 mute!	input 1 volume mute	
s cec in x vol-!	set input x volume down by CEC, x=0~4(0=all input)	s cec in 1 vol-!	input 1 volume down	
s cec in x vol+!	set input x volume up by CEC, x=0~4(0=all input)	s cec in 1 vol+!	input 1 volume up	

s cec in x ff!	set input x fast forward by CEC, x=0~4(0=all input)	s cec in 1 ff!	input 1 fast forward operation	
s cec in x previous!	set input x previous by CEC, x=0~4(0=all input)	s cec in 1 previous!	input 1 previous operation	
s cec in x next!	set input x next by CEC, x=0~4(0=all input)	s cec in 1 next!	input 1 next operation	
s cec hdmi out y on!	set hdmi output y power on by CEC, y=0~4(0=all output)	s cec hdmi out 1 on!	hdmi output 1 power on	
s cec hdmi out y off!	set hdmi output y power off by CEC, y=0~4(0=all output)	s cec hdmi out 1 off!	hdmi output 1 power off	
s cec hdmi out y mute!	set hdmi output y volume mute by CEC, y=0~4(0=all output)	s cec hdmi out 1 mute!	hdmi output 1 volume mute	
s cec hdmi out y vol-!	set hdmi output y volume down by CEC, y=0~4(0=all output)	s cec hdmi out 1 vol-!	hdmi output 1 volume down	
s cec hdmi out y vol+!	set hdmi output y volume up by CEC, y=0~4(0=all output)	s cec hdmi out 1 vol+!	hdmi output 1 volume up	
s cec hdmi out y active!	set hdmi output y active source by CEC, y=0~4(0=all output)	s cec hdmi out 1 active!	hdmi output 1 active source	

EDID Setting				
s edid in x from z! Set input x EDID from default EDID Z, x=0~4(0=all),z=1~31 1: 1080p, Stereo Audio 2.0 2: 1080p, Dolby/DTS 5.1 3: 1080p, HD Audio 7.1 4: 1080i, Stereo Audio 2.0 5: 1080i, Dolby/DTS 5.1 6: 1080i, HD Audio 7.1 7: 3D, Stereo Audio 2.0 8: 3D, Dolby/DTS 5.1 9: 3D, HD Audio 7.1 10: 4K2K30_444, Stereo Audio 2.0 11: 4K2K30_444, Dolby/DTS 5.1 12: 4K2K30_444, HD Audio 7.1 13: 4K2K60_420, Stereo Audio 2.0 14: 4K2K60_420, Dolby/DTS 5.1 15: 4K2K60_420, HD Audio 7.1 16: 4K2K60_444, Stereo Audio 2.0 17: 4K2K60_444, Dolby/DTS 5.1 18: 4K2K60_444, HD Audio 7.1 19: 4K2K60_444, Stereo Audio 2.0 HDR 20: 4K2K60_444, Dolby/DTS 5.1 HDR 21: 4K2K60_444, HD Audio 7.1 HDR 22: USER1 23: USER2 24: copy from HDMI output 1 25: copy from	s edid in 1 from 1! s edid in 0 from 1!	input 1 EDID:1080p,Stereo Audio 2.0 all inputs EDID:1080p,Stereo Audio 2.0	1080p,Stereo Audio 2.0	

	HDMI output 2 26: copy from HDMI output 3 27: copy from HDMI output 4 28: copy from cat output 1 29: copy from cat output 2 30: copy from cat output 3 31: copy from cat output 4			
r edid in x!	Get EDID status of the input. X, x=0~4(0=all input)	r edid in 0!	input 1 EDID: 4K2K60_444, Stereo Audio 2.0 input 2 EDID: 4K2K60_444, Stereo Audio 2.0 input 3 EDID: 4K2K60_444, Stereo Audio 2.0 input 4 EDID: 4K2K60_444, Stereo Audio 2.0	
r edid data hdmi y!	Get the EDID data of the HDMI output y port, y=1~4	r edid data hdmi 1!	EDID : 00 FF FF FF FF FF FF 00 hdmi output 1: disconnect	

Network Setting				
r ipconfig!	Get the Current IP Configuration	r ipconfig !	IP Mode: Static IP: 192.168.1.72 Subnet Mask: 255.255.255.0 Gateway: 192.168.1.1 TCP/IP port=8000 Telnet port=10 Mac address: 00:1C:91:03:80:01 Mac address: 6C:DF:FB:0D:59:7 4	
r mac addr!	Get network MAC address	r mac addr!	Mac address: 00:1C:91:03:80:01	
s ip mode z!	Set network IP mode to static IP or DHCP, z=0~1 (z=0 Static, z=1 DHCP)	s ip mode 0!	Set IP mode:Static. (Please use "s net reboot!" command or repower device to apply new config!)	
r ip mode!	Get network IP mode	r ip mode!	IP mode: Static	
s ip addr xxx.xxx.xxx.xxx!	Set network IP address	s ip addr 192.168.1.100!	Set IP address:192.168.1.100 Please use "s net reboot!" command or repower device to apply new config! DHCP on, Device can't config static address, set DHCP off first.	
r ip addr!	Get network IP address	r ip addr!	IP address:192.168.1.100	
s subnet xxx.xxx.xxx.xxx!	Set network subnet mask	s subnet 255.255.255.0!	Set subnet Mask:255.255.255.0 (Please use "s net reboot!" command or repower device to apply new config!) DHCP on, Device can't config subnet mask, set DHCP off first.	
r subnet!	Get network subnet mask	r subnet!	Subnet Mask:255.255.255.0	

s gateway xxx.xxx.xxx.xxx!	Set network gateway	s gateway 192.168.1.1!	Set gateway:192.168. 1.1 (Please use "s net reboot!" command or repower device to apply new config!) DHCP on, Device can't config gateway, set DHCP off first.	
r gateway!	Get network gateway	r gateway!	Gateway:192.168. 1.1	
s tcp/ip port x!	Set network TCP/IP port (x=1~65535)	s tcp/ip port 8000!	Set TCP/IP port:8000	
r tcp/ip port!	Get network TCP/IP port	r tcp/ip port!	TCP/IP port:8000	
s telnet port x!	Set network telnet port(x=1~65535)	s telnet port 23!	Set Telnet port:23	
r telnet port!	Get network telnet port	r telnet port!	Telnet port:23	
s net reboot!	Reboot network modules	s network reboot!	Network reboot... IP Mode: Static IP: 192.168.1.72 Subnet Mask: 255.255.255.0 Gateway: 192.168.1.1 TCP/IP port=8000 Telnet port=10 Mac address: 00:1C:91:03:80:01	

EDID Management

For ensuring maximum compatibility, the matrix has 21 stored EDID settings, 2 user-defined settings and 8 copy settings. These can be managed using RS-232 or Web-Gui control methods.

For RS-232 use, follow the RS-232 control setup and input the commands as specified in the list above.

For Web-Gui use, please check the EDID management setting in the Input tab. Please see above for further information.

EDID List

EDID Mode	EDID Description	EDID Mode	EDID Description
1	1080P, Stereo Audio 2.0	22	User Defined 1
2	1080P, Dolby/DTS 5.1	23	User Defined 2
3	1080P, HD Audio 7.1	24	Copy_From_HDMI 1
4	1080I, Stereo Audio 2.0	25	Copy_From_HDMI 2
5	1080I, Dolby/DTS 5.1	26	Copy_From_HDMI 3
6	1080I, HD Audio 7.1	27	Copy_From_HDMI 4
7	3D, Stereo Audio 2.0	28	Copy_From_CAT 1
8	3D, Dolby/DTS 5.1	29	Copy_From_CAT 2
9	3D, HD Audio 7.1	30	Copy_From_CAT 3
10	4K2K30_444, Stereo Audio 2.0	31	Copy_From_CAT 4
11	4K2K30_444, Dolby/DTS 5.1		
12	4K2K30_444, HD Audio 7.1		
13	4K2K60_420, Stereo Audio 2.0		
14	4K2K60_420, Dolby/DTS 5.1		
15	4K2K60_420, HD Audio 7.1		
16	4K2K60_444, Stereo Audio 2.0		
17	4K2K60_444, Dolby/DTS 5.1		
18	4K2K60_444, HD Audio 7.1		
19	4K2K60, Stereo Audio 2.0 HDR		
20	4K2K60, Dolby/DTS 5.1 HDR		
21	4K2K60, HD Audio 7.1, HDR		

Troubleshooting**There is no display on the screen.**

It has been found that there are significant differences in the cable lengths/types and even input ports which can be used on different brands of display using HDMI resolutions. If problems are experienced, please apply the following steps:

- Reset the matrix extender or receiver unit using the reset push button.
- Try a different input port on the display.
- Reduce the cable length on the Input and Output to 1m.
- Try a different type of 1m HDMI Cable.
- Check that the DC plug and jack used by the external power supply is firmly connected.
- Check that the Cat.6 or above cable is connected correctly.
- Power off all the devices, then power on in this order: first, the matrix unit, then the display and finally the source.
- For some HDMI devices it may be helpful to unplug and re-connect their HDMI connection to re-initiate the HDMI handshake and recognition.
- Reduce the length of Cat.6 or HDMI cable used or use a higher quality cable.

Lindy regularly checks and tests our product range to ensure maximum compatibility and performance. For the most up to date version of this manual, please refer to your local Lindy website, search for the relevant part number and find the manual under Downloads.

For further assistance please contact your local Lindy Technical Support team. Details can be found at your local Lindy website.

Recycling Information



WEEE (Waste of Electrical and Electronic Equipment), Recycling of Electronic Products

Europe, United Kingdom

In 2006 the European Union introduced regulations (WEEE) for the collection and recycling of all waste electrical and electronic equipment. It is no longer allowable to simply throw away electrical and electronic equipment. Instead, these products must enter the recycling process. Each individual EU member state, as well as the UK, has implemented the WEEE regulations into national law in slightly different ways. Please follow your national law when you want to dispose of any electrical or electronic products. More details can be obtained from your national WEEE recycling agency.

The following batteries or accumulators are included in this electrical appliance

Battery Quantity and Type	Chemical System
1 x CR2025	Lithium Polymer

Information on the safe removal of batteries or accumulators

1. Warning: Make sure the battery is completely drained.
2. Open the battery cover on the bottom of the remote control.
3. Carefully remove the battery or accumulator.
4. The battery or accumulator and the device can now be disposed of separately.

Germany / Deutschland Elektro- und Elektronikgeräte

Informationen für private Haushalte sowie gewerbliche Endverbraucher

Hersteller-Informationen gemäß § 18 Abs. 4 ElektroG (Deutschland)

Das Elektro- und Elektronikgerätegesetz (ElektroG) enthält eine Vielzahl von Anforderungen an den Umgang mit Elektro- und Elektronikgeräten. Die wichtigsten sind hier zusammengestellt.

1. Bedeutung des Symbols „durchgestrichene Mülltonne“



Das auf Elektro- und Elektronikgeräten regelmäßig abgebildete Symbol einer durchgestrichenen Mülltonne weist darauf hin, dass das jeweilige Gerät am Ende seiner Lebensdauer getrennt vom unsortierten Siedlungsabfall zu erfassen ist.

2. Getrennte Erfassung von Altgeräten

Elektro- und Elektronikgeräte, die zu Abfall geworden sind, werden als Altgeräte bezeichnet. Besitzer von Altgeräten haben diese einer vom unsortierten Siedlungsabfall getrennten Erfassung zuzuführen. Altgeräte gehören insbesondere nicht in den Hausmüll, sondern in spezielle Sammel- und Rückgabesysteme.

3. Batterien und Akkus sowie Lampen

Besitzer von Altgeräten haben Altbatterien und Altakkumulatoren, die nicht vom Altgerät umschlossen sind, sowie Lampen, die zerstörungsfrei aus dem Altgerät entnommen werden können, im Regelfall vor der Abgabe an einer Erfassungsstelle vom Altgerät zu trennen. Dies gilt nicht, soweit Altgeräte einer Vorbereitung zur Wiederverwendung unter Beteiligung eines öffentlich-rechtlichen Entsorgungsträgers zugeführt werden.

Information gemäß § 4 Absatz 4 Elektroggesetz

Folgende Batterien bzw. Akkumulatoren sind in diesem Elektrogerät enthalten

Batterieanzahl und -typ	Chemisches System
1 x CR2025	Lithium Polymer

Angaben zur sicheren Entnahme der Batterien oder der Akkumulatoren

- Warnhinweis: Vergewissern sie sich, ob die Batterie entleert ist.
- Öffnen Sie das Batteriefach an der Unterseite der Fernbedienung.
- Entnehmen Sie vorsichtig die Batterie oder den Akkumulator.
- Die Batterie bzw. der Akkumulator und das Gerät können jetzt getrennt entsorgt werden.

4. Möglichkeiten der Rückgabe von Altgeräten

Besitzer von Altgeräten aus privaten Haushalten können diese bei den Sammelstellen der öffentlich-rechtlichen Entsorgungsträger oder bei den von Herstellern oder Vertreibern im Sinne des ElektroG eingerichteten Rücknahmestellen unentgeltlich abgeben.

Rücknahmepflichtig sind Geschäfte mit einer Verkaufsfläche von mindestens 400 m² für Elektro- und Elektronikgeräte sowie diejenigen Lebensmittelgeschäfte mit einer Gesamtverkaufsfläche von mindestens 800 m², die mehrmals pro Jahr oder dauerhaft Elektro- und Elektronikgeräte anbieten und auf dem Markt bereitstellen. Dies gilt auch bei Vertrieb unter Verwendung von Fernkommunikationsmitteln, wenn die Lager- und Versandflächen für Elektro- und Elektronikgeräte mindestens 400 m² betragen oder die gesamten Lager- und Versandflächen mindestens 800m² betragen. Vertreter haben die Rücknahme grundsätzlich durch geeignete Rückgabemöglichkeiten in zumutbarer Entfernung zum jeweiligen Endnutzer zu gewährleisten.

Die Möglichkeit der unentgeltlichen Rückgabe eines Altgerätes besteht bei rücknahmepflichtigen Vertreibern unter anderem dann, wenn ein neues gleichartiges Gerät, das im Wesentlichen die gleichen Funktionen erfüllt, an einen Endnutzer abgegeben wird. Wenn ein neues Gerät an einen privaten Haushalt ausgeliefert wird, kann das gleichartige Altgerät auch dort zur unentgeltlichen Abholung übergeben werden; dies gilt bei einem Vertrieb unter Verwendung von Fernkommunikationsmitteln für Geräte der Kategorien 1, 2 oder 4 gemäß § 2 Abs. 1 ElektroG, nämlich „Wärmeüberträger“, „Bildschirmgeräte“ oder „Großgeräte“ (letztere mit mindestens einer äußeren Abmessung über 50 Zentimeter). Zu einer entsprechenden Rückgabe-Absicht werden Endnutzer beim Abschluss eines Kaufvertrages befragt. Außerdem besteht die Möglichkeit der unentgeltlichen Rückgabe bei Sammelstellen der Vertreter unabhängig vom Kauf eines neuen Gerätes für solche Altgeräte, die in keiner äußeren Abmessung größer als 25 Zentimeter sind, und zwar beschränkt auf drei Altgeräte pro Geräteart.

5. Datenschutz-Hinweis

Altgeräte enthalten häufig sensible personenbezogene Daten. Dies gilt insbesondere für Geräte der Informations- und Telekommunikationstechnik wie Computer und Smartphones. Bitte beachten Sie in Ihrem eigenen Interesse, dass für die Löschung der Daten auf den zu entsorgenden Altgeräten jeder Endnutzer selbst verantwortlich ist.

France

En 2006, l'union Européenne a introduit la nouvelle réglementation (DEEE) pour le recyclage de tout équipement électrique et électronique. Chaque Etat membre de l'Union Européenne a mis en application la nouvelle réglementation DEEE de manières légèrement différentes. Veuillez suivre le décret d'application correspondant à l'élimination des déchets électriques ou électroniques de votre pays.

Italy

Nel 2006 l'unione europea ha introdotto regolamentazioni (WEEE) per la raccolta e il riciclo di apparecchi elettrici ed elettronici. Non è più consentito semplicemente gettare queste apparecchiature, devono essere riciclate. Ogni stato membro dell'EU ha tramutato le direttive WEEE in leggi statali in varie misure. Fare riferimento alle leggi del proprio Stato quando si dispone di un apparecchio elettrico o elettronico. Per ulteriori dettagli fare riferimento alla direttiva WEEE sul riciclaggio del proprio Stato.

España

En 2006, la Unión Europea introdujo regulaciones (WEEE) para la recolección y reciclaje de todos los residuos de aparatos eléctricos y electrónicos. Ya no está permitido simplemente tirar los equipos eléctricos y electrónicos. En cambio, estos productos deben entrar en el proceso de reciclaje. Cada estado miembro de la UE ha implementado las regulaciones de WEEE en la legislación nacional de manera ligeramente diferente. Por favor, siga su legislación nacional cuando desee deshacerse de cualquier producto eléctrico o electrónico. Se pueden obtener más detalles en su agencia nacional de reciclaje de WEEE.

CE/FCC Statement

CE Certification

LINDY declares that this equipment complies with relevant European CE requirements.

CE Konformitätserklärung

LINDY erklärt, dass dieses Equipment den europäischen CE-Anforderungen entspricht

UKCA Certification

LINDY declares that this equipment complies with relevant UKCA requirements.

FCC Certification

This equipment has been tested and found to comply with the limits for a Class B digital device, pursuant to part 15 of the FCC Rules. These limits are designed to provide reasonable protection against harmful interference in a residential installation.

You are cautioned that changes or modification not expressly approved by the party responsible for compliance could void your authority to operate the equipment.

This device complies with part 15 of the FCC Rules.

Operation is subject to the following two conditions:

1. This device may not cause harmful interference, and
2. This device must accept any interference received, including interference that may cause undesired operation.

The enclosed power supply has passed Safety test requirements, conforming to the US American versions of the international Standard IEC 60950-1 or 60065 or 62368-1.

LINDY Herstellergarantie – Hinweis für Kunden in Deutschland

LINDY gewährt für dieses Produkt über die gesetzliche Regelung in Deutschland hinaus eine zweijährige Herstellergarantie ab Kaufdatum. Die detaillierten Bedingungen dieser Garantie finden Sie auf der LINDY Website aufgelistet bei den AGBs.

Hersteller / Manufacturer (EU):

LINDY-Elektronik GmbH
Markircher Str. 20
68229 Mannheim
Germany
Email: info@lindy.com, T: +49 (0)621 470050

Manufacturer (UK):

LINDY Electronics Ltd
Sadler Forster Way
Stockton-on-Tees, TS17 9JY
England
sales@lindy.co.uk, T: +44 (0)1642 754000



No. 38328 V2
2nd Edition, November 2022
lindy.com